

Portion-Aire® Bench Top Dispensers

Designed to dispense all fluids from watery thin to thick pastes.

Glenmarc Portion-Aire® dispensers increase productivity and quality through controlled accurate repeatable applications of adhesives, fluids, lubricants, and pastes.

Versatile and easy to use, many dispenser configurations and accessories are available to provide the features and equipment needed to meet your specific fluid dispensing process.

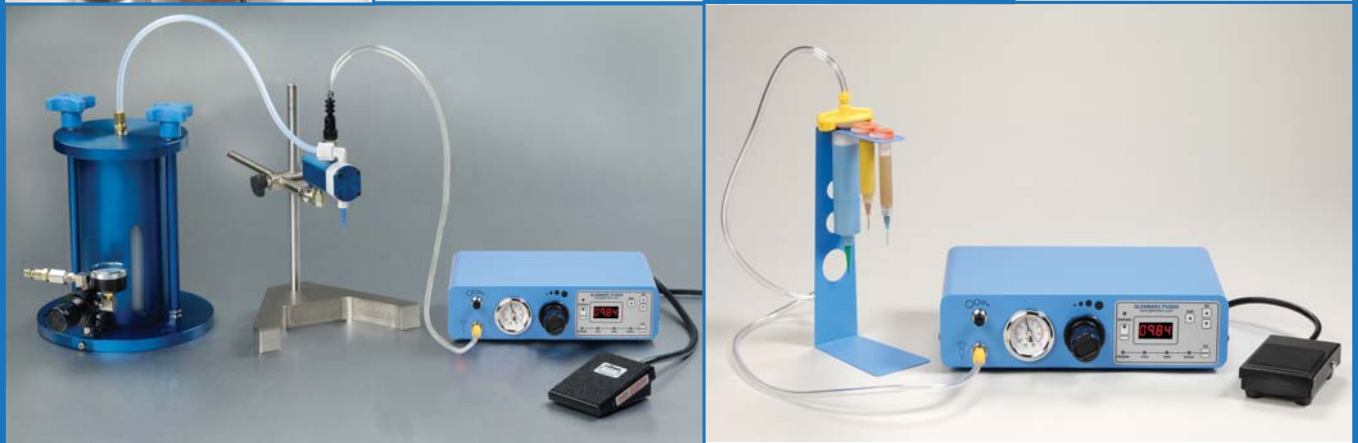

GLENMARC FOUNDED 1968
OVER 35 YEARS DISPENSER
MACHINE EXPERIENCE



GLENMARC
INDUSTRIES INC.

2001 S. BLUE ISLAND AVE.
CHICAGO, IL 60608

PH 312-243-0800
FAX 312-243-4670
TOLL FREE 800-323-5350

EMAIL info@glenmarc.com
WEB www.glenmarc.com

Portion-Aire® Dispenser PV4000

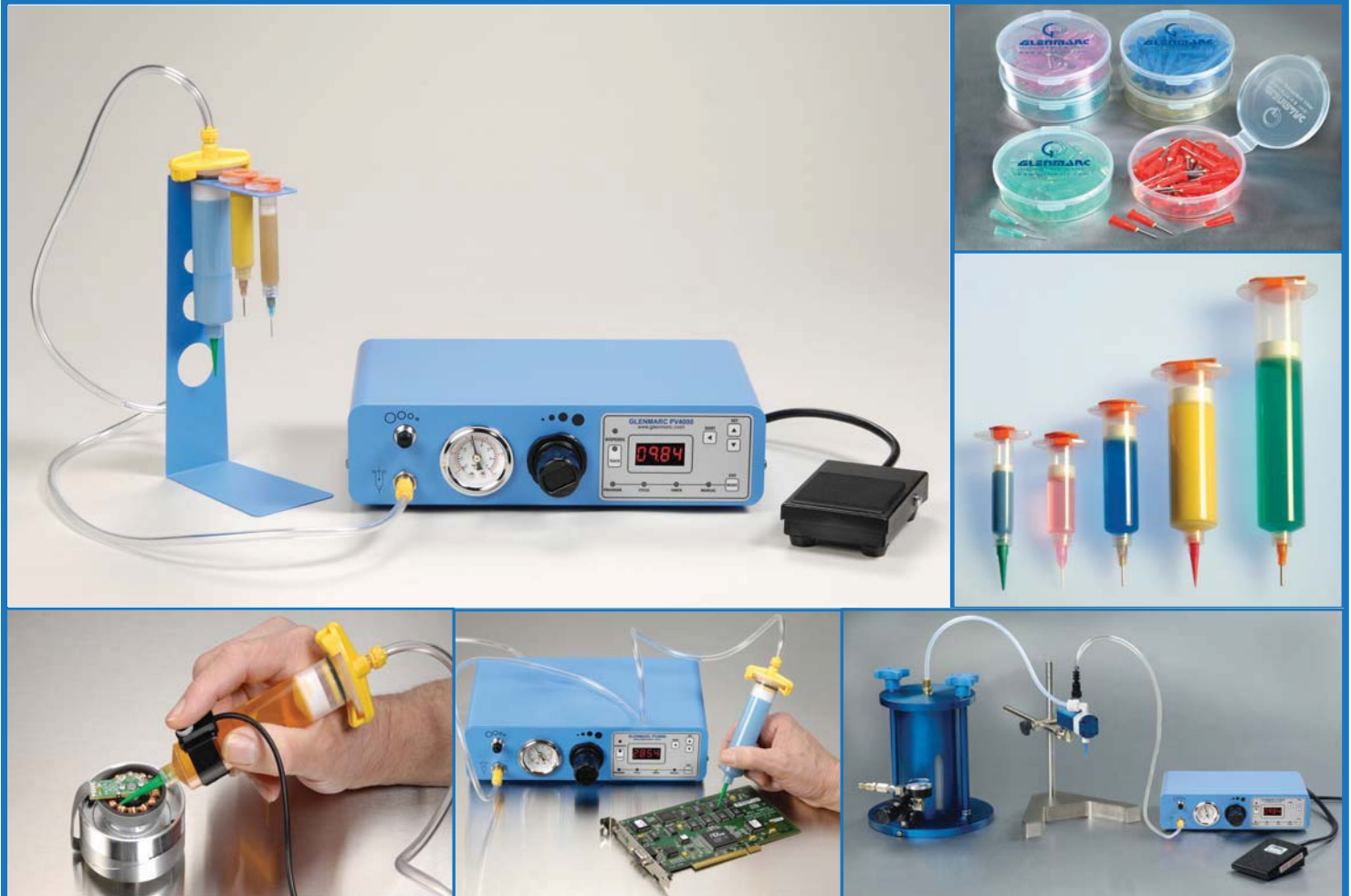

Glenmarc Portion-Aire® dispenser PV4000 designed to accurately dispense all fluids from watery thin to thick pastes includes timed shot with LED digital display, key pad timer adjustment, vacuum no drip.

FEATURES

- FAST REPEATABLE DOTS, BEADS, LINES, AND FILLS, DISPENSES ALL TYPE OF FLUIDS AND PASTES
- SHOTS DISPENSED BY TIMED DISPENSE, MANUAL ON/OFF, TIMED DISPENSE CYCLE (REPEATING DISPENSE)
- VACUUM SUCK BACK CONTROL TO PREVENT DRIPPING OR STRINGING
- HOLDS UP TO 40 SHOT TIMES AND PROGRAMS IN MEMORY, EVEN AFTER POWER IS OFF
- TEACH MODE FOR FAST AND ACCURATE SHOT SIZE SET UP
- CYCLE MODE FOR REPEATING DISPENSE TIME ON AND OFF INTERVAL TIME FOR EASY AUTOMATION
- HIGHLY ACCURATE DIGITAL TIMER WITH LARGE BRIGHT LED READOUT FOR EASY TO SEE OPERATION
- LARGE PRESSURE GAUGE DIAL WITH EASY TO SEE NUMBERS IN BOTH PSI AND KPA BAR SCALE
- COMES WITH A WIDE RANGE OF ACCESSORIES
- COMPACT BENCH TOP DESIGN WITH INDUSTRIAL ALL METAL POWDER COATED PAINTED CASE (NO PLASTIC)
- HIGH QUALITY RAPID RESPONSE SOLENOID VALVE FOR FAST PRECISE TIMED DISPENSING ACCURATE TO 0.01 SEC
- DESIGNED AND MANUFACTURED IN CHICAGO, IL USA WITH 2 YEAR WARRANTY
- EASY OPERATOR SET UP, CAN BE DISPENSING 5 MINUTES AFTER OPENING BOX
- CAN ALSO BE USED WITH DISPENSE CARTRIDGES AND VALVES, MANY ACCESSORIES AVAILABLE

GLENMARC FOUNDED 1968
OVER 35 YEARS DISPENSER
MACHINE EXPERIENCE



GLENMARC
INDUSTRIES INC.

2001 S. BLUE ISLAND AVE.
CHICAGO, IL 60608

PH 312-243-0800
FAX 312-243-4670
TOLL FREE 800-323-5350

EMAIL info@glenmarc.com
WEB www.glenmarc.com

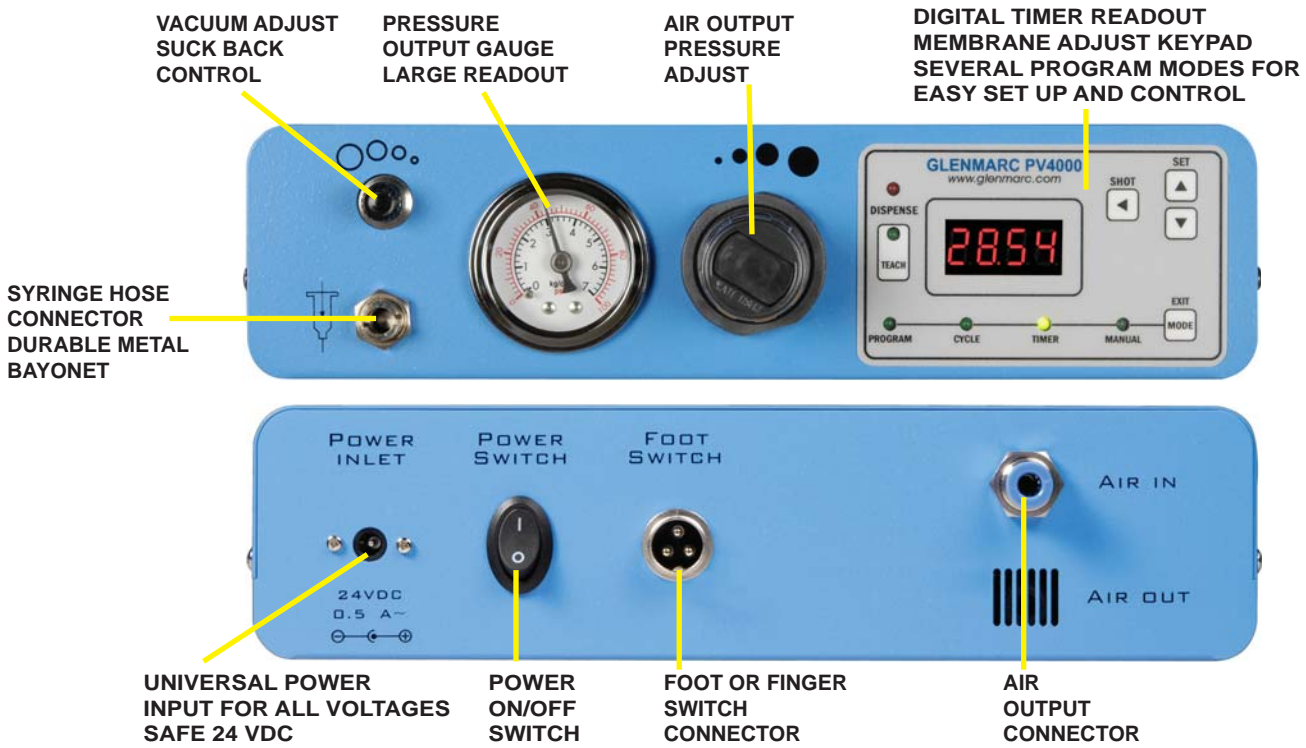

INCLUDED WITH THE PV4000 ARE:

Powder coated steel syringe and needle holder stand.

Syringe adapter assembly
With 3 Foot (91 cm) air line
With quick connect.

Fits 30cc and 55cc (Standard)
Or specify your choice of 3cc, 5cc, 10cc
(Also longer lengths available, specify)

Disposable needle evaluation kits

Syringe kit (Sample syringes, pistons, caps and tip caps)

Instruction manual
Foot switch, 24 VDC plug in power supply
air input hose w/quick connect
Two Year warranty

See the Glenmarc Portion-Aire®
Brochures for Syringe Adapter
Assemblies, Syringes, Needles,
Syringe Stands and accessories.

GLENMARC PART NUMBERS:

PV4000DT FOR MOST FLUIDS (0-100 PSI)

PV4015DT FOR THIN FLUIDS (0-15 PSI)



OPTIONAL FINGER SWITCH
PART# 530-0020

PV4000 SERIES SPECIFICATIONS:

Solid State Timer: 0.01 - 99.99 seconds

Air Input Requirements: 10 psi (0.7 bar) to 150 psi (10 bar) Max

Air Output: PV4000DT 0-100 psi (0-7 bar)
PV4015DT 0-15 psi (0-1.05 bar)

Functions: Timed shot, manual dispense, teach mode,
cycle mode, internal memory holds 40 set ups.

Operating Voltage: 110 to 240 VAC 50/60 Hz 1 Amps
Internal 24 VDC supplied via power adapter

Cycle Initiate: Foot pedal switch (Standard)
Finger switch or other (Optional)

Maximum Cycle Rate: 800 Cycles Per Minute

Ambient Operating Conditions:

Temperature 41F-110F (5C-45C)
Humidity 85% RH at 30C non-condensing
Altitude 6562 Ft (2000 meters)

Cabinet Dimensions:

Height: 2.8 Inches (7.1 cm)
Width: 8.3 Inches (21.1 cm)
Depth of Cabinet: 10.4 Inches (26.4 cm)
Weight 6.5 pounds (2.95 kg)
Material: All metal steel case powder coated paint (no plastic)

Portion-Aire® Dispenser PV3000



Glenmarc Portion-Aire® dispenser PV3000 designed to accurately dispense all fluids from watery thin to thick pastes, uses robot controller w/cable, footswitch, or fingerswitch for shot dispense.

FEATURES

- FAST REPEATABLE DOTS, BEADS, LINES, AND FILLS, DISPENSES ALL TYPE OF FLUIDS AND PASTES
- SHOTS DISPENSED BY ROBOT CONTROLLER W/CABLE, FOOTSWITCH, OR FINGERSWITCH.
- VACUUM SUCK BACK CONTROL TO PREVENT DRIPPING OR STRINGING
- USE FOR EASY AUTOMATION
- HIGH QUALITY RAPID RESPONSE SOLENOID VALVE FOR FAST PRECISE TIMED DISPENSING ACCURATE TO 0.01 SEC
- LARGE PRESSURE GAUGE DIAL WITH EASY TO SEE NUMBERS IN BOTH PSI AND KPA BAR SCALE
- COMES WITH A WIDE RANGE OF ACCESSORIES
- COMPACT BENCH TOP DESIGN WITH INDUSTRIAL ALL METAL POWDER COATED PAINTED CASE (NO PLASTIC)
- DESIGNED AND MANUFACTURED IN CHICAGO, IL USA WITH 2 YEAR WARRANTY
- EASY OPERATOR SET UP, CAN BE DISPENSING 5 MINUTES AFTER OPENING BOX
- CAN ALSO BE USED WITH DISPENSE CARTRIDGES AND VALVES, MANY ACCESSORIES AVAILABLE

GLENMARC FOUNDED 1968
OVER 35 YEARS DISPENSER
MACHINE EXPERIENCE



GLENMARC
INDUSTRIES INC.

2001 S. BLUE ISLAND AVE.
CHICAGO, IL 60608

PH 312-243-0800
FAX 312-243-4670
TOLL FREE 800-323-5350

EMAIL info@glenmarc.com
WEB www.glenmarc.com

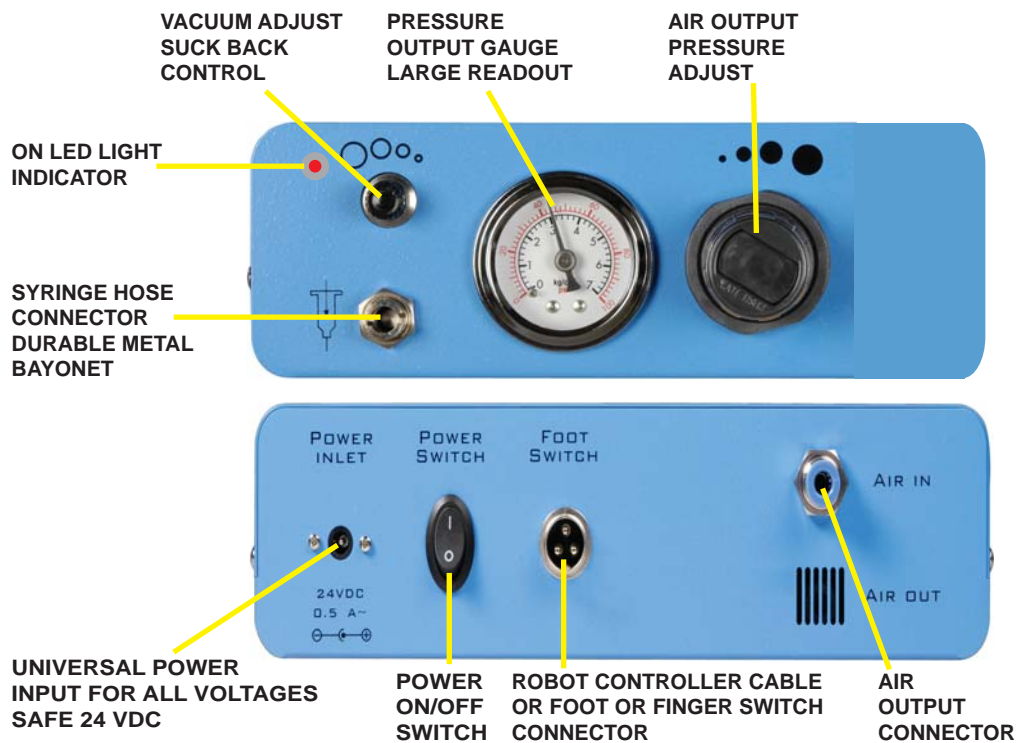

INCLUDED WITH THE PV3000 ARE:

Powder coated steel syringe and
needle holder stand.

Syringe adapter assembly
With 3 Foot (91 cm) air line
With quick connect.

Fits 30cc and 55cc (Standard)
Or specify your choice of 3cc, 5cc, 10cc
(Also longer lengths available, specify)

Disposable needle evaluation kits

Syringe kit (Sample syringes, pistons,
caps and tip caps)

Instruction manual
Foot switch, 24 VDC plug in power supply
air input hose w/quick connect
Two Year warranty

See the Glenmarc Portion-Aire[®]
Brochures for Syringe Adapter
Assemblies, Syringes, Needles,
Syringe Stands and accessories.

GLENMARC PART NUMBERS:

PV3000 FOR MOST FLUIDS (0-100 PSI)

PV3015 FOR THIN FLUIDS (0-15 PSI)



OPTIONAL FINGER SWITCH
PART# 530-0020

PV3000 SERIES SPECIFICATIONS:

Air Input Requirements: 10 psi (0.7 bar) to 150 psi (10 bar) Max

Air Output: PV3000 0-100 psi (0-7 bar)
PV3015 0-15 psi (0-1.05 bar)

Functions: Robot controlled dispenser
Manual shot by footswitch or fingerswitch

Operating Voltage: 110 to 240 VAC 50/60 Hz 1 Amps
Internal 24 VDC supplied via power adapter

Cycle Initiate: Foot pedal switch (Standard)
Finger switch or other (Optional)

Maximum Cycle Rate: 800 Cycles Per Minute

Ambient Operating Conditions:
Temperature 41F-110F (5C-45C)
Humidity 85% RH at 30C non-condensing
Altitude 6562 Ft (2000 meters)

Cabinet Dimensions:
Height: 2.8 Inches (7.1 cm)
Width: 6.5 Inches (16.5 cm)
Depth of Cabinet: 6.0 Inches (5.3 cm)
Weight 3.0 pounds (1.4 kg)
Material: All metal steel case powder coated paint (no plastic)

Portion-Aire[®] 2K Dispensing Tool for dual 50ML Cartridges



Glenmarc Portion-Aire[®] 2K Dispensing tool accurately dispenses two-component (2K) material packaged in dual 50 ml 1:1 and 2:1 ratio cartridges using static mix tubes to make a complete economical meter/mix/dispense solution. Works with Glenmarc and all third party electro-pneumatic fluid dispensers.

FEATURES

- USE ANY 2K ADHESIVES WHICH ARE SUPPLIED IN 50 ML CARTRIDGES (GELMARC ALSO HAS CARTRIDGE FILLING SERVICE)
- CNC MACHINED ALUMINUM RETAINER IS VERY DURABLE YET LIGHT WEIGHT FOR HAND HELD USE
- OPTIONAL STAND MOUNT PROVIDES HANDS FREE OPERATION, CAN ALSO BE USED FOR XYZ ROBOT DISPENSING
- CONNECTOR PROVIDED ON TOP OF CAP FOR TOLL BALANCER USE
- LARGE POWERFUL INTERNAL PNEUMATIC PISTON FOR FAST REPEATABLE DOTS, BEADS, LINES, AND FILLS
- SHOTS CAN BE DISPENSED BY TIMED DISPENSE, MANUAL ON/OFF, TIMED DISPENSE CYCLE (REPEATING DISPENSE)
- CAN USE VACUUM SUCK BACK CONTROL TO PREVENT DRIPPING OR STRINGING
- DESIGNED AND MANUFACTURED IN CHICAGO, IL USA WITH 1 YEAR WARRANTY
- EASY OPERATOR SET UP, CAN BE DISPENSING 5 MINUTES AFTER OPENING BOX
- COMES WITH 4 FOOT AIR LINE WITH BAYONET ON END TO CONNECT UP TO GLENMARC FLUID DISPENSERS

SPECIFICATIONS:

MATERIALS: CNC MACHINED 6061 ALUMINUM WITH DURABLE ANODIZED COATING

CARTRIDGE TYPE: 50 ML 1:1 AND 2:1 RATIO 2K SIDE BY SIDE CARTRIDGES THAT PUSH THE ADHESIVE THROUGH A STATIC MIXING NOZZLE

LENGTH (OVER ALL WITHOUT CARTRIDGE): 160 mm , **DIAMETER MIDDLE:** 45 mm, **DIAMETER CAP:** 50 mm **DIAMETER BOTTOM :** 54 mm

WEIGHT: 350 GRAMS

MAXIMUM PRESSURE: 110 PSI

GLENMARC PART NUMBERS: CBHC501 is for 1:1 ratio complete assembly including airline

CBHC502 is for 2:1 ratio complete assembly including airline

GLENMARC FOUNDED 1968
OVER 50 YEARS DISPENSER
MACHINE EXPERIENCE



2001 S. BLUE ISLAND AVE.
CHICAGO, IL 60608

PH 312-243-0800
FAX 312-243-4670
TOLL FREE 800-323-5350

EMAIL info@glenmarc.com
WEB www.glenmarc.com

Portion-Aire® Manual Dispense Systems PM100 Series

Simple economical pneumatic dispenser. The PM100 can do a wide range of applications, such as lay down accurate glue lines, paint stripes, dispense grease blobs and dots, fill bottles, apply heat sink and pipe pastes, pot housings, and any process where a dispense is needed.



For Syringe barrels:

Includes: Three way air valve foot pedal with 5 foot (152 cm) lines
0 to 100 PSI pressure gauge with regulator and mounting bracket
One syringe adapter assembly with 3 foot (91cm) air line with quick disconnect and check valve and
Syringes, pistons, dispense needles accessories kit.

GLENMARC PART NUMBERS:

- PM103** Comes with 3cc syringe adapter assembly
- PM105** Comes with 5cc syringe adapter assembly
- PM110** Comes with 10cc syringe adapter assembly
- PM130** Comes with 30cc/55cc syringe adapter assembly
- PSS** Optional syringe and dispense needle stand



For Cartridges:

Includes: Three way air valve foot pedal with 5 foot (152 cm) lines
0 to 100 PSI pressure gauge with regulator and mounting bracket
One cartridge holder, cartridge holder cap, disposable cartridge and piston
One 4 foot (122 cm) cartridge air line with quick disconnects and check valve and
Cartridge nozzle accessories kit.

GLENMARC PART NUMBERS:

- PM102** Comes with 2-1/2 oz cartridge set
- PM106** Comes with 6 oz cartridge set
- PM112** Comes with 12 oz cartridge set
- PM120** Comes with 20 oz cartridge set
- PM210** Comes with 1/10 Gal caulking cartridge set
- PSC12** Optional cartridge holder stand for 2-1/2 oz to 12 oz cartridges
- PSC20** Optional cartridge holder stand for 20 oz cartridge
- 2405001** Adapter for cartridge to accept Luer-Lock dispense needles



FEATURES

- MANUAL OPERATION, EASY TO USE, ECONOMICAL
- WIDE RANGE OF APPLICATIONS AND FLUID TYPES DISPENSED, NUMEROUS ACCESSORIES AVAILABLE
- LARGE PRESSURE GAUGE DIAL WITH EASY TO SEE NUMBERS IN BOTH PSI AND KPA BAR SCALE
- REGULATOR HAS MOUNTING BRACKET TO MOUNT ON TABLE TOP FOR EASY PRESSURE ADJUST AND GAUGE SIGHT
- PROVIDES A FAST MATERIAL CUT-OFF BY UTILIZING A VALVE THAT RELIEVES RESIDUAL AIR PRESSURE BUILD UP
- DESIGNED AND MANUFACTURED IN CHICAGO, IL USA WITH 2 YEAR WARRANTY

PERFORMANCE

- EASY OPERATOR SET UP
- SET THE REGULATOR PRESSURE THEN DEPRESS THE FOOT PEDAL UNTIL THE DESIRED AMOUNT IS DISPENSED
- FAST REPEATABLE DOTS, BEADS, LINES, BLOBS, AND FILLS, DISPENSES ALL TYPES OF FLUID AND PASTES

GLENMARC FOUNDED 1968
OVER 35 YEARS DISPENSER
MACHINE EXPERIENCE



2001 S. BLUE ISLAND AVE.
CHICAGO, IL 60608

PH 312-243-0800
FAX 312-243-4670
TOLL FREE 800-323-5350

EMAIL info@glenmarc.com
WEB www.glenmarc.com

PORTION-AIRE® CARTRIDGE HOLDERS / CAPS AND DISPOSABLE CARTRIDGES / PISTONS AND ACCESSORIES

PORTION-AIRE® Cartridge Holders And Caps

Size	Holder and Cap Set	Holder Replacement	Cap (Includes Checkvalve) Replacement
2-1/2 Oz	CBHC02	CBH02	CBCA
6 Oz	CBHC06	CBH06	CBCA
12 Oz	CBHC12	CBH12	CBCA
20 Oz	CBHC20	CBH20	CBC20
1/10 Gal	CBHC10	CBH10	CBC10

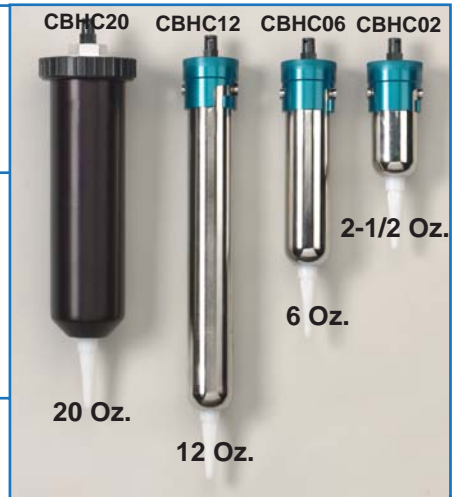

Part Number Description

CBCAG	Replacement Gasket for CBCA
2903002	Male Quick Connect, Fits 1/8" ID Hose
2903003	Replacement Checkvalve for Caps, Has Female Quick Connect
DMC4	Air line, Double Male Quick connect at both ends, 4 Foot
2405001	Adapter Fits into Cartridges to accept LuerLock Dispense Needles
PSC12	Cartridge Holder Stand Fits 2-1/2 Oz to 12 Oz Cartridges
PSC20	Cartridge Holder Stand Fits 20 Oz Cartridge

PORTION-AIRE® Cartridges, Pistons, and End caps

Size	Disposable Cartridges	Disposable Pistons	Cartridge Top End Caps	Cartridge Bottom Screw in Caps
2-1/2 Oz	CP02	P2612	CPSC50 (10 PKG)	CPTC50 (10 PKG)
6 Oz	CP06	P2612	CPSC50 (10 PKG)	CPTC50 (10 PKG)
12 Oz	CP12	P2612	CPSC50 (10 PKG)	CPTC50 (10 PKG)
20 OZ	CP20	P20	CPSC20 (10 PKG)	CPTC50 (10 PKG)

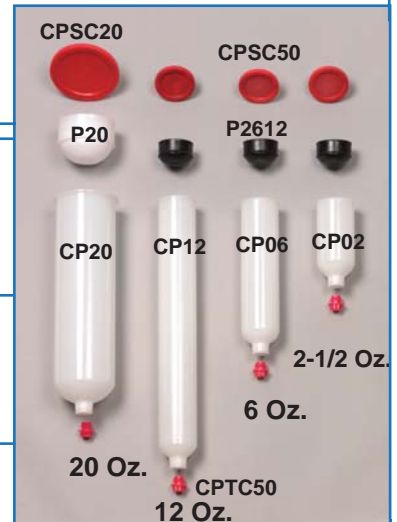

PORTION-AIRE® Nozzles

Part Number	Description (All have 1/4 NPT Male Thread)	PKG QTY
CNP252	2-1/2 Inch Long, 1/16 Inch ID Opening	10
CNP254	2-1/2 Inch Long, 1/8 Inch ID Opening	10
CNP420	4 Inch Long, 1/16 Inch ID Opening	10
CNP440	4 Inch Long, 1/8 Inch ID Opening	10
CNP8645	4-3/8 Inch Long, 1 Inch x 1/8 Inch Opening	10



Note: Large Selection of Nozzles are Available Consult Glenmarc for Additional Sizes.

GLENMARC HAS BEEN SUPPLYING THE INDUSTRY WITH DISPENSING COMPONENTS SINCE 1968
ALL DISPENSING COMPONENTS ARE IN STOCK AND SHIP THE SAME DAY



2001 S. BLUE ISLAND AVE.
CHICAGO, IL 60608

PH 312-243-0800
FAX 312-243-4670
TOLL FREE 800-323-5350

EMAIL info@glenmarc.com
WEB www.glenmarc.com

GLENMARC HEAVY DUTY ADJUSTABLE STAND TO HOLD CARTRIDGES, SYRINGES, AND VALVES

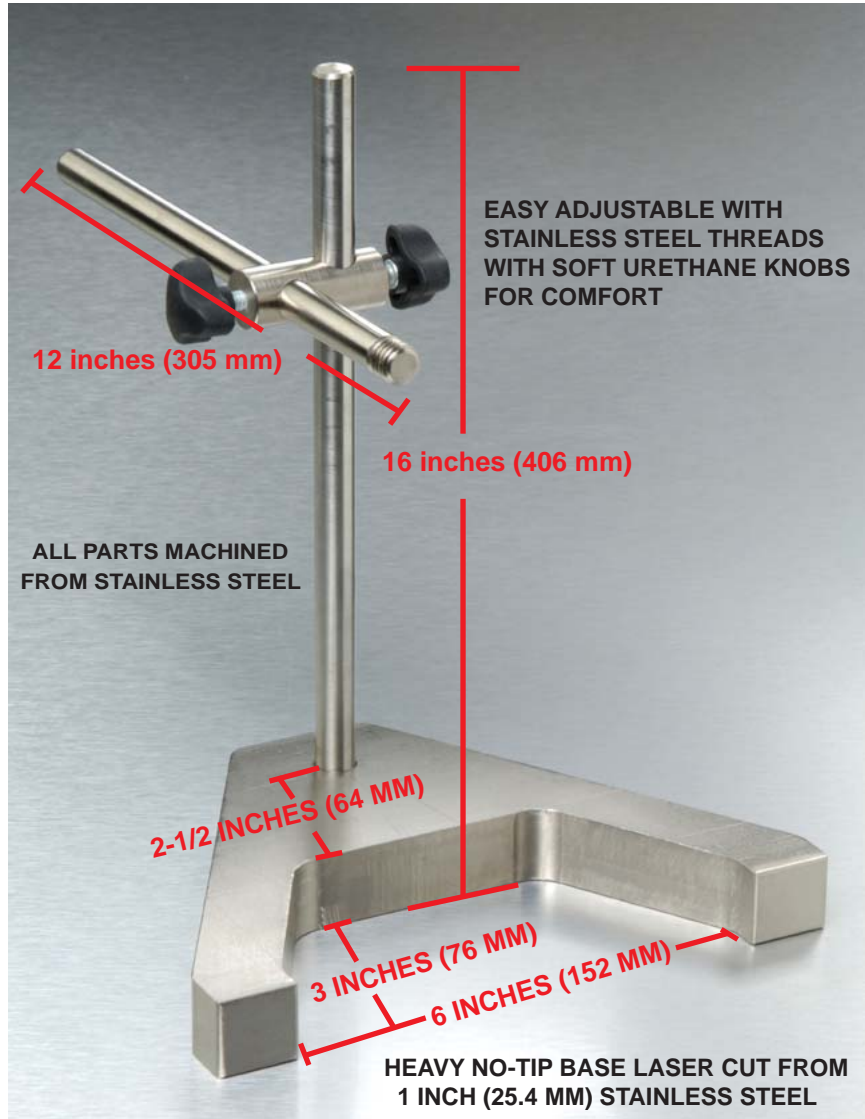

GLENMARC PART NUMBERS:
TO HOLD 20 OZ CARTRIDGE **PART# PSC20**
TO HOLD DISPENSE VALVE **PART# PSCVALVE**
TO HOLD 30CC AND 50 CC SYRINGES **PART# PSC30**
TO HOLD 2-1/2, 6, 12 OZ CARTRIDGES **PART# PSC12**
TO HOLD 50 ML DUAL CARTRIDGE PUSHER **PART# PSC50**
TO HOLD 1/10 GAL AND 300 ML CAULKING CARTRIDGE **PART# PSC10**

GLENMARC CAN ALSO MAKE ANY CUSTOM OR SPECIAL STAND AND/OR SIZE HOLDER
CONSULT GLENMARC ENGINEERING FOR MORE INFORMATION



2001 S. BLUE ISLAND AVE.
CHICAGO, IL 60608

PH 312-243-0800
FAX 312-243-4670
TOLL FREE 800-323-5350

EMAIL info@glenmarc.com
WEB www.glenmarc.com

PORTION-AIRE® DISPOSABLE SYRINGE BARRELS AND PISTONS



Evaluation Kit for Syringe Barrels, Pistons, Sealing Tops and Tip Caps.
Part # SLLKIT Includes one size each of clear syringe barrels, white PE pistons, Tops and Tip Caps.

PORTION-AIRE® Syringe Barrel And Piston Sets

Size	Clear Barrels	Light Block Amber Barrels	Opaque Black Barrels	Quantity Per Pack/Bag
3cc	SLP03P	SLPA03P	SLPB03P	50
3cc	SLP03B	SLPA03B	SLPB03B	1000
5cc	SLP05P	SLPA05P	SLPB05P	50
5cc	SLP05B	SLPA05B	SLPB05B	1000
10cc	SLP10P	SLPA10P	SLPB10P	50
10cc	SLP10B	SLPA10B	SLPB10B	1000
30cc	SLP30P	SLPA30P	SLPB30P	50
30cc	SLP30B	SLPA30B	SLPB30B	1000
55cc	SLP55P	SLPA55P	SLPB55P	50
55cc	SLP55B	SLPA55B	SLPB55B	1000

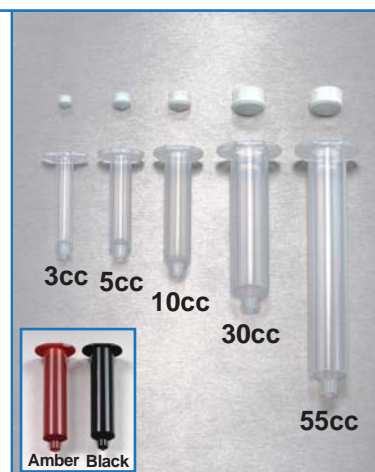

PORTION-AIRE® Syringe Barrels

Size	Clear Barrels	Light Block Amber Barrels	Opaque Black Barrels	Quantity Per Pack/Bag
3cc	SLL03P	SLLA03P	SLLB03P	50
3cc	SLL03B	SLLA03B	SLLB03B	1000
5cc	SLL05P	SLLA05P	SLLB05P	50
5cc	SLL05B	SLLA05B	SLLB05B	1000
10cc	SLL10P	SLLA10P	SLLB10P	50
10cc	SLL10B	SLLA10B	SLLB10B	1000
30cc	SLL30P	SLLA30P	SLLB30P	50
30cc	SLL30B	SLLA30B	SLLB30B	1000
55cc	SLL55P	SLLA55P	SLLB55P	50
55cc	SLL55B	SLLA55B	SLLB55B	1000



GLENMARC HAS BEEN SUPPLYING THE INDUSTRY WITH DISPENSING COMPONENTS SINCE 1968
ALL DISPENSING COMPONENTS ARE IN STOCK AND SHIP THE SAME DAY



2001 S. BLUE ISLAND AVE.
CHICAGO, IL 60608

PH 312-243-0800
FAX 312-243-4670
TOLL FREE 800-323-5350

EMAIL info@glenmarc.com
WEB www.glenmarc.com

PORTION-AIRE® DISPOSABLE SYRINGE BARRELS AND PISTONS

PORTION-AIRE® Barrel Pistons						WHITE PE	
Size	White PE Pistons	Rubber Black Pistons	Thick Fluid Red Pistons	Thin Fluid Blue Pistons	Quantity Per Pack/Bag		
3cc	SPP03P	SRP03P	SHVP03P	SLVP03P	50	RUBBER BLACK	
3cc	SPP03B	SRP03B	SHVP03B	SLVP03B	1000		
5cc	SPP05P	SRP05P	SHVP05P	SLVP05P	50	THICK FLUID RED	
5cc	SPP05B	SRP05B	SHVP05B	SLVP05B	1000		
10cc	SPP10P	SRP10P	SHVP10P	SLVP10P	50	THIN FLUID BLUE	
10cc	SPP10B	SRP10B	SHVP10B	SLVP10B	1000		
30/55cc	SPP30P	SRP30P	SHVP30P	SLVP30P	50	3cc 5cc 10cc 30/55cc	
30/55cc	SPP30B	SRP30B	SHVP30B	SLVP30B	1000		

PORTION-AIRE® Barrel Sealing Caps And Tip Caps W/Luer Lock				SEALING CAP SBC	
Size	End Cap	Tip Cap	Quantity Per Pack/Bag		
3cc	SBC03P	SLLTCP	50	3cc 5cc 10cc 30/55cc	
3cc	SBC03B	SLLTCB	1000		
5cc	SBC05P	SLLTCP	50		
5cc	SBC05B	SLLTCB	1000		
10cc	SBC10P	SLLTCP	50		
10cc	SBC10B	SLLTCB	1000		
30/55cc	SBC30P	SLLTCP	50		
30/55cc	SBC30B	SLLTCB	1000		

PORTION-AIRE® Barrel Adapter Assemblies								
Size	'A' Style Adapter assemblies			'B' Style Adapter assemblies				
	3ft(914mm) hose	6ft(1829mm) hose	3ft(914mm) hose w/inline filter	3ft(914mm) hose	6ft(1829mm) hose	3ft(914mm) hose w/inline filter	Oring Buna Pack 10	Oring EPR Pack 10
3cc	SAA03	SAA603	SAAF03	SAB03	SAB603	SABF03	SABR03	SABEPR03
5cc	SAA05	SAA605	SAAF05	SAB05	SAB605	SABF05	SABR05	SABEPR05
10cc	SAA10	SAA610	SAAF10	SAB10	SAB610	SABF10	SABR10	SABEPR10
30/55cc	SAA30	SAA630	SAAF30	SAB30	SAB630	SABF30	SABR30	SABEPR30

'A' Style Barrel Adapter Assemblies

'B' Style Barrel Adapter Assemblies

Adapter w/inline filter

Inline disposable filter capsule kit, installs on syringe adapter assembly
Includes filter capsules and hose clamps for 5 adapters assemblies
Part# SAFBC
Pack 5

SAFBC

PORTION-AIRE® DISPOSABLE DISPENSE NEEDLE TIPS

PORTION-AIRE® DN Stainless Steel Needle Tips



Material: Polypropylene Hub With Polished 304 Stainless Steel Needle

Gauge	0.50" Long	1.0" Long	1.5" Long	Quantity per Pack/Bag	Color	ID Size Inch(mm)	OD Size Inch(mm)
● 14	DN14050P	DN14100P	DN14150P	50	Ivory	○ 0.067(1.70)	0.083(2.11)
	DN14050B	DN14100B	DN14150B	1000			
● 15	DN15050P	DN15100P	DN15150P	50	Orange	● 0.060(1.52)	0.072(1.83)
	DN15050B	DN15100B	DN15150B	1000			
● 16	DN16050P	DN16100P	DN16150P	50	Purple	● 0.047(1.19)	0.065(1.65)
	DN16050B	DN16100B	DN16150B	1000			
● 17	DN17050P	DN17100P	DN17150P	50	White	○ 0.043(1.09)	0.059(1.50)
	DN17050B	DN17100B	DN17150B	1000			
● 18	DN18050P	DN18100P	DN18150P	50	Pink	● 0.039(0.99)	0.050(1.27)
	DN18050B	DN18100B	DN18150B	1000			
● 19	DN19050P	DN19100P	DN19150P	50	Brown	● 0.031(0.79)	0.042(1.07)
	DN19050B	DN19100B	DN19150B	1000			
● 20	DN20050P	DN20100P	DN20150P	50	Yellow	● 0.025(0.64)	0.036(0.91)
	DN20050B	DN20100B	DN20150B	1000			
● 21	DN21050P	DN21100P	DN21150P	50	Aqua	● 0.022(0.56)	0.032(0.81)
	DN21050B	DN21100B	DN21150B	1000			
● 22	DN22050P	DN22100P	DN22150P	50	Charcoal	● 0.019(0.48)	0.028(0.71)
	DN22050B	DN22100B	DN22150B	1000			
● 23	DN23050P	DN23100P	DN23150P	50	Lt. Blue	● 0.016(0.41)	0.025(0.64)
	DN23050B	DN23100B	DN23150B	1000			
● 25	DN25050P	DN25100P	DN25150P	50	Blue	● 0.012(0.31)	0.020(0.51)
	DN25050B	DN25100B	DN25150B	1000			
● 26	DN26050P	DN26100P	DN26150P	50	Tan	● 0.010(0.25)	0.018(0.46)
	DN26050B	DN26100B	DN26150B	1000			
● 27	DN27050P	DN27100P	DN27150P	50	Gray	● 0.009(0.23)	0.016(0.41)
	DN27050B	DN27100B	DN27150B	1000			
● 30	DN30050P			50	Lavender	● 0.006(0.15)	0.012(0.31)
	DN30050B			1000			

Note: Needle Tolerances \pm 0.00075in (0.019mm)

GLENMARC HAS BEEN SUPPLYING THE INDUSTRY WITH DISPENSING COMPONENTS SINCE 1968
ALL DISPENSING COMPONENTS ARE IN STOCK AND SHIP THE SAME DAY



2001 S. BLUE ISLAND AVE.
CHICAGO, IL 60608

PH 312-243-0800
FAX 312-243-4670
TOLL FREE 800-323-5350

EMAIL info@glenmarc.com
WEB www.glenmarc.com

PORTION-AIRE® DISPOSABLE DISPENSE NEEDLE TIPS

PORTION-AIRE® PN Tapered Tips



**Material: Rigid Polyethylene
Opaque With UV Light Block**

Gauge	1.25" Long	Quantity per Pack/Bag	Color	ID Size Inch(mm)
● 14	PN14P	50	Olive ●	0.061(1.55)
	PN14B	1000		
● 16	PN16P	50	Gray ●	0.047(1.20)
	PN16B	1000		
● 18	PN18P	50	Green ●	0.033(0.84)
	PN18B	1000		
● 20	PN20P	50	Pink ●	0.024(0.60)
	PN20B	1000		
● 22	PN22P	50	Blue ●	0.016(0.41)
	PN22B	1000		
● 25	PN25P	50	Red ●	0.010(0.26)
	PN25B	1000		

PORTION-AIRE® FN Flexible Tips



**Material: Polypropylene Hub
With Flexible Polypropylene
Tubing Tip**

Tubing Can Be Cut to Length

Gauge	0.50" Long	1.5" Long	Quantity per Pack/Bag	Color	ID Size Inch(mm)
● 14	FN14050P	FN14150P	50	Olive ●	0.063(1.60)
	FN14050B	FN14150B	1000		
● 15	FN15050P	FN15150P	50	Amber ●	0.047(1.20)
	FN15050B	FN15150B	1000		
● 18	FN18050P	FN18050P	50	Green ●	0.032(0.80)
	FN18050B	FN18150B	1000		
● 20	FN20050P	FN20150P	50	Pink ●	0.024(0.60)
	FN20050B	FN20150B	1000		
● 22	FN22050P	FN22150P	50	Blue ●	0.016(0.40)
	FN22050B	FN22150B	1000		
● 25	FN25050P	FN25150P	50	Red ●	0.012(0.30)
	FN25050B	FN25150B	1000		

PORTION-AIRE[®] DISPOSABLE DISPENSE NEEDLE TIPS

PORTION-AIRE[®] TN Teflon Tips



**Material: Polypropylene Hub
With Flexible Teflon
Tubing Tip**

Gauge	0.50" Long	Quantity per Pack/Bag	Color	ID Size Inch(mm)
• 14	TN14050P	50	Olive ●	0.063(1.60)
	TN14050B	1000		
• 16	TN16050P	50	Gray ●	0.047(1.20)
	TN16050B	1000		
• 18	TN18050P	50	Green ●	0.032(0.80)
	TN18050B	1000		
• 20	TN20050P	50	Pink ●	0.024(0.60)
	TN20050B	1000		
• 22	TN22050P	50	Blue ●	0.016(0.40)
	TN22050B	1000		
• 24	TN24050P	50	Orange ●	0.010(0.26)
	TN24050B	1000		
• 30	TN30050P	50	Purple ●	0.006(0.16)
	TN30050B	1000		

PORTION-AIRE[®] TL Teflon Lined Tips



**Material: Polypropylene Hub
With Stainless Steel 304
Needle with Teflon Lining**

Gauge	0.50" Long	1.0" Long	Quantity per Pack/Bag	Color	ID Size Inch(mm)
• 21	TL21050P	TL21100P	50	Gray ●	0.063(1.60)
	TL21050B	TL21100B	1000		
• 25	TL25050P	TL25100P	50	Pink ●	0.047(1.20)
	TL25050B	TL25100B	1000		

DISPOSABLE HAND OPERATED SYRINGES



Hand Operated Syringe with Plunger (Assembled)

Size	Syringe W/Plunger	Quantity Per Pack/Bag
3cc	SHP03P	50
3cc	SHP03B	1000
5cc	SHP05P	50
5cc	SHP05B	1000
10cc	SHP10P	50
10cc	SHP10B	1000
30cc	SHP30P	50
30cc	SHP30B	1000
55cc	SHP55P	50
55cc	SHP55B	1000

Evaluation Kit For Hand Operated Syringe/Plunger.
Part # SHPKIT Includes one size of each with tip cap.

Material: Polypropylene Syringe/Plunger With Rubber Neoprene Piston
Note: All hand syringes and plungers come completely assembled
Syringes have Luer Lock connection for wide range of needle tips



Tip Cap W/Luer Lock For Syringes

Size	Tip Cap	Quantity Per Pack/Bag
ALL	SLLTCP	50
ALL	SLLTCB	1000

Material: Polypropylene
Color: Black



GLENMARC HAS BEEN SUPPLYING THE INDUSTRY WITH DISPENSING COMPONENTS SINCE 1968
ALL DISPENSING COMPONENTS ARE IN STOCK AND SHIP THE SAME DAY



2001 S. BLUE ISLAND AVE.
CHICAGO, IL 60608

PH 312-243-0800
FAX 312-243-4670
TOLL FREE 800-323-5350

EMAIL info@glenmarc.com
WEB www.glenmarc.com

DISPOSABLE HAND OPERATED SYRINGES WITH NYLON PISTON (RUBBER AND SILICONE FREE)



Hand Operated Syringe with Plunger (Assembled)

Size	Syringe W/Plunger	Quantity Per Pack/Bag
3cc	SHN03P	50
3cc	SHN03B	1000
5cc	SHN05P	50
5cc	SHN05B	1000
10cc	SHN10P	50
10cc	SHN10B	1000
30cc	SHN30P	50
30cc	SHN30B	1000
60cc	SHN60P	50
60cc	SHN60B	1000

Evaluation Kit For Hand Operated Syringe/Plunger.
Part # SHNKIT Includes one size of each with tip cap.

Material: Polypropylene Syringe With Nylon Plunger And Piston
Note: All hand syringes and plungers come completely assembled
Syringes have Luer Lock connection for wide range of needle tips

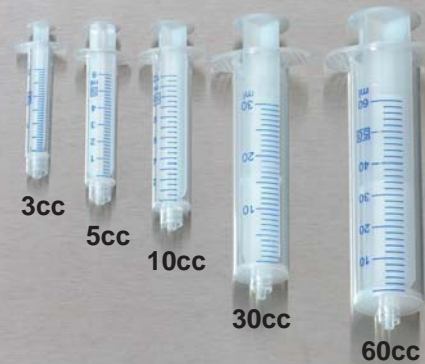

Tip Cap W/Luer Lock For Syringes

Size	Tip Cap	Quantity Per Pack/Bag
ALL	SLLTCP	50
ALL	SLLTCB	1000

Material: Polypropylene
Color: Black



GLENMARC HAS BEEN SUPPLYING THE INDUSTRY WITH DISPENSING COMPONENTS SINCE 1968
ALL DISPENSING COMPONENTS ARE IN STOCK AND SHIP THE SAME DAY



2001 S. BLUE ISLAND AVE.
CHICAGO, IL 60608

PH 312-243-0800
FAX 312-243-4670
TOLL FREE 800-323-5350

EMAIL info@glenmarc.com
WEB www.glenmarc.com

PORTION-AIRE® DISPENSERS



GLENMARC HAS BEEN SUPPLYING THE INDUSTRY WITH DISPENSING COMPONENTS SINCE 1968

ALL DISPENSING COMPONENTS SHIP THE SAME DAY



**SYRINGE BARRELS
PISTONS / CAPS**



DISPENSE NEEDLES



PORTION-AIRE® DISPENSE VALVES

DISPENSE VALVES FOR ADHESIVES, EPOXIES, CA GLUES, GREASES, LUBRICANTS, INKS, PAINTS, PASTES, SOLDER MASKS, SILICONES, ALL FLUIDS.



GLENMARC FOUNDED 1968 OVER 35 YEARS DISPENSE VALVE EXPERIENCE



COMPLETE BENCH TOP SYSTEMS, VALVES FOR AUTOMATED LINES AND MACHINE BUILDERS. COMPLETE LINE OF ACCESSORIES, VALVE CONTROLLERS, FLUID RESERVOIRS, AND DISPENSE TIPS.

PORTION-AIRE® DISPENSE CARTRIDGE SYSTEMS



GLENMARC
FOUNDED 1968

ADHESIVE DISPENSING

POTTING, BONDING, CASTING, SEALING

OVER 35 YEARS
METER MIX
MACHINE
EXPERIENCE

PORTIONATOR® METER, MIX, DISPENSE MACHINES



AUTOMIX PORTIONATOR AM1000 WITH REMOTE GUN



DYNAMIC MIXER

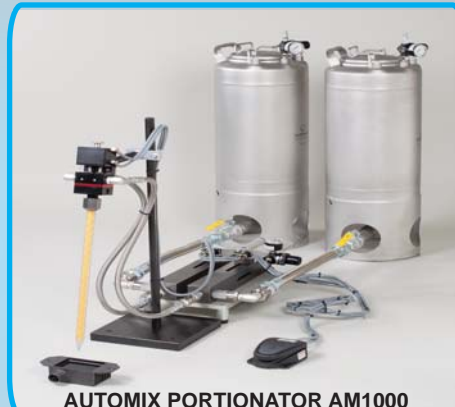

AUTOMIX PORTIONATOR AM1000

MANUAL AND AUTOMATIC SYSTEMS FOR TWO-COMPONENT
METER, MIXING, AND DISPENSING OF EPOXY, URETHANE, AND SILICONE



PHONE 312-243-0800 FAX 312-243-4670
www.glenmarc.com



GLENMARC
INDUSTRIES INC.
2001 S. Blue Island Ave.
Chicago, IL 60608